

AN ACOUSTIC AND THERMAL SOLUTION

ArmaSound Industrial Systems

By combining thermal insulation and noise reduction into a single modular solution, ArmaSound Industrial Systems offer innovative noise control solutions to use in oil and gas applications with a unique benefit - minimises the risk of corrosion under insulation.

www.armacell.com/oilandgas



 **armacell**[®]
ArmaSound[®]

PIONEERS

ArmaSound is an example of how an outstanding hybrid solution based on the ArmaFlex® product suite delivers additional customer benefits. The first noise control system to minimise the risk of corrosion under insulation (CUI). Combined thermal insulation and noise reduction in a single solution. Significant savings in installation and maintenance costs. Low thickness and weight. Proven performance, worldwide. Standardised systems that meet ISO 15665 classifications and bespoke solutions to satisfy specific acoustic and thermal project specific challenges. Armacell's answer to true innovation for the oil and gas industry.

Proven performance, installed on iconic offshore and onshore projects worldwide.

Sound performance



Thermal performance



Reduces risk of CUI



[Learn more](#)

ARMASOUND INDUSTRIAL SYSTEMS

ArmaSound Industrial Systems comprise several combinations of thermal (ArmaFlex® Industrial / ArmaGel) and acoustic (ArmaSound®) insulation layers. Depending on project requirements, various cladding materials (such as Arma-Chek® R polymeric covering, metal cladding or glass-reinforced plastic cladding) can be used. Plus, it provides significant noise reduction for all process pipework typically used in oil and gas industries.



FEATURES & BENEFITS

While each of the individual insulation materials used in our acoustic insulation systems comes with its own set of features and benefits, superior performance is achieved when optimally engineered together.

We innovate and focus on materials and systems that deliver superior performance.

// Designed to deliver

We have developed a dedicated range of industrial materials meeting the demanding requirements of the oil and gas sector.

// Lifetime performance

Resistance to water and water vapour ingress, plus an optimal system design delivers long-term predictable thermal and acoustic stability and enhanced process performance.

// Two in one

Our insulation materials combine thermal and acoustic performance and can also be engineered with traditional insulation materials for specific demands.

// Resistant to damage

Flexible materials that do not crack, break or crumble and are resistant to vibration and mechanical abuse.

// Integrated vapour barrier

ArmaFlex and the Arma-Chek covering systems are flexible and resilient to both water and water vapour ingress.

// Training and technical support

Our team of technical experts support operators, engineers and contractors in optimising the value gained from using our insulation systems. We can offer a reliable technical service at every stage of your project.

Flexible, thinner and lighter systems. Easy maintenance. Connecting your business with lower lifecycle costs.

// Reduce space and weight

Lightweight and up to 40% reduced thickness for improved space efficiency and a smaller plant footprint, reduced supporting steel work and weight. Less cladding materials are required with lower installation costs.

// Straightforward installation

Our flexible insulation materials are easy and quick to install and fabricate, leading to reduced installation time and costs. They also fit better reducing rework and wastage.

// Easy inspection and maintenance

Simple methods and non-destructive inspection can save time and money.

// Supply chain benefits

Materials can be pre-fabricated at the jobsite, unlike traditional systems and materials, leading to reduced SKUs and inventory for both projects and ongoing operations.

Mitigate the spread of corrosion under insulation. Best-in-class noise reduction.

// Protect workers and the environment from noise

ArmaFlex and ArmaGel based ArmaSound Industrial Systems offers enhanced protection for workers and the surrounding environment from plant noise.

// Reduce the risk of CUI

Our closed-cell ArmaFlex and hydrophobic ArmaGel insulation materials are proven to reduce the onset and spread of CUI.

// Prevent moisture ingress

We select our materials and design our systems to create a tortuous path for water - this minimises the risk of it travelling from the outside of the pipe to the surface, reducing the risks of CUI.

// Reduce the risk of water trapped at the pipe surface

Flexible materials and application techniques means a better fit around complex parts and no voids between insulation and pipe where water could otherwise collect with rigid or less flexible materials.

// Eliminate the risk of galvanic corrosion

Systems qualified with non-metallic jacketing eliminates the opportunity for galvanic corrosion.



THE COMPONENTS



The secret is in the engineered multi-layer design: higher efficiency, thinner and lighter. A deep understanding of the different insulation materials and how they behave when used together, led us to the development of ArmaSound Industrial Systems. Each system is tested and evaluated by independent, internationally renowned acoustic institutes and laboratories.



UP TO
30%
INSTALLED COST
SAVINGS

UP TO
75%
THINNER
SYSTEMS

MULTIPLE SYSTEMS, MULTIPLE USES

ArmaSound Industrial Systems are available in various insulation and cladding configurations for industrial applications ranging from -40 °C to +650 °C (-40 °F to 1200 °F).

OUR SECRET: ENGINEERED LAYER DESIGN

// ArmaFlex® Industrial: high performance thermal insulation

ArmaFlex is Armacell's product heritage. Today, in its 7th product generation, this flexible, light-weight, high-tech material features an insulating closed-cell structure with low thermal conductivity and an in-built water vapour barrier. It is fibre-dust free, and a key element in our layering system for effective acoustic decoupling (isolation).

// ArmaGel HT: sound decoupling and absorption

With excellent thermal properties, ArmaGel HT is hydrophobic and repels water. It mitigates the risk of CUI and endures high temperatures up to 650 °C. As part of the acoustic system, ArmaGel layers are a key element for effective acoustic decoupling (isolation) and sound absorption. Its low dynamic stiffness and optimised air flow resistance provide excellent acoustic absorption across a wide frequency range.

// ArmaSound® RD240: enhanced sound absorption

ArmaSound RD240 is an advanced open-cell, fibre-dust free acoustic insulation material. It offers excellent sound absorption behaviour across the entire frequency range. This, coupled with its high density and inherent damping ability, provides excellent acoustic performance in thinner layers than traditional systems. It is also suitable in some applications as an acoustic barrier.

// ArmaSound® Barrier E: efficient sound barrier

ArmaSound Barrier E is a vinyl sound barrier mat loaded with naturally occurring minerals. The product is free of lead, unrefined aromatic oils and bitumen. With its high density, the product combines minimum thickness with an excellent reduction of the transmission of air-borne sound while enhancing the insertion loss performance of pipe insulation system.

// Arma-Chek® R cladding: durable mechanical protection

Arma-Chek R is a particularly resilient, non-metallic flexible cladding system formulated with CSPE. Reducing the corrosion and installation issues associated with metallic covering systems, Arma-Chek R has been designed to work in harmony with ArmaFlex insulation, expanding and contracting as required. Plus, it enhances the insertion loss performance of our acoustic insulation systems.

FOR
TEMPERATURES FROM
-40 °C to +650 °C
[-40 °F - 1200 °F]



PROVEN PERFORMANCE

ArmaSound Industrial Systems are tested by recognised institutes and satisfy - and in many cases exceed - the requirements of the main standards on noise control, such as ISO 15665 Class A to Class C, Class D acc. to Shell DEP 31.46.00.31 specification, Norsok standard R-004 (M-004) Class 6, 7 and 8 and ASTM E 1222.

ArmaSound in practice: acoustic treatment of plants

The graphics below illustrate typical noise levels and potential noise reduction around a gas processing plant without acoustic treatment (fig. 1) and with ArmaSound Industrial Systems acoustic treatment (fig. 2).

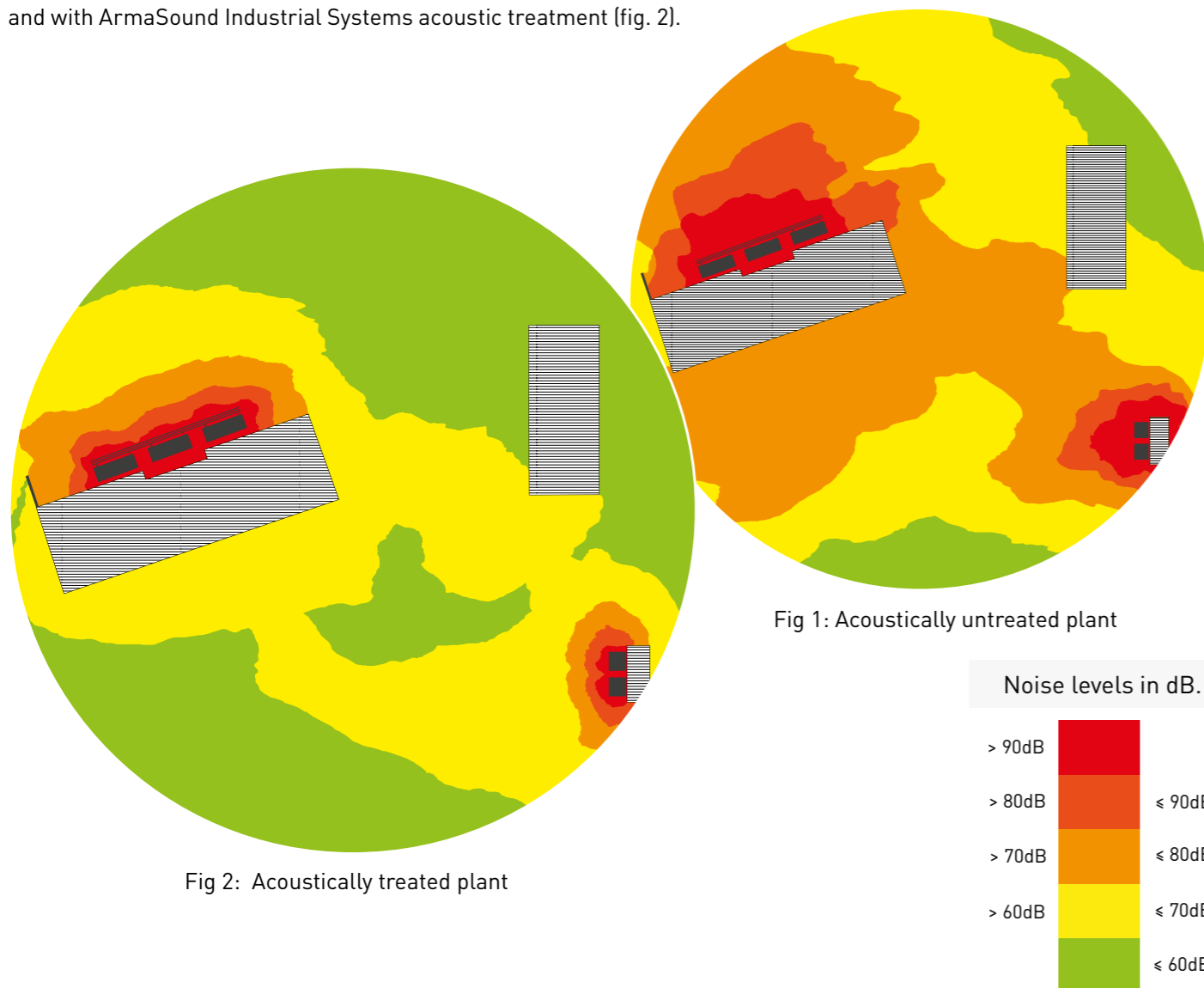

Caring about Health, Safety & Environment

Reduced noise levels are inherently beneficial for the environment. The impact of noise from industrial plants has significant effects on health, safety and the environment. Noise induced hearing loss, compromised communication, cost of amenity and detrimental effects on wildlife are all consequences of a noisy plant. Using our ArmaSound Industrial Systems help noise attenuation in valves and pipework and should be a cornerstone in any plants' noise reduction strategy.



PERFORMANCE DELIVERED

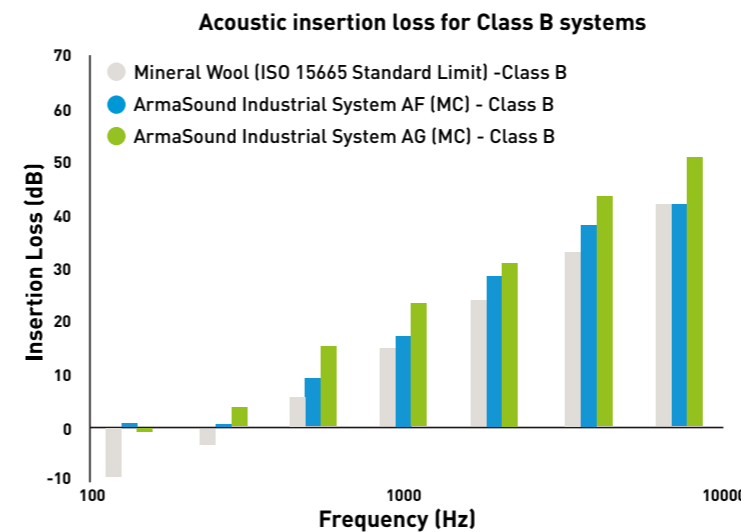

EXCELLENT RESULTS

Class-based classification requires that a system design meets or exceeds the performance of a traditional mineral wool-based acoustic system. All ArmaSound Industrial Systems configurations meet the classifications of ISO 15665.

The enhanced low frequency performance means that in many cases a lower class of ArmaSound Industrial System (ArmaFlex or ArmaGel based) can be recommended as a thinner, lighter, lower-cost alternative to a higher class of mineral wool-based acoustic system.

* Example based on ISO 15665 calculations

Learn more: [our services](#)

Efficient and practical engineering solutions for your acoustic and insulation challenges:

- Acoustic surveys / system design
- Specification support
- TIPCHECK energy audit
- Bespoke proof-point testing
- System optimisation
- MTO - material take off tool
- Technical training
- Mock up and trial installation
- Installation instructions
- Application training
- Inspection and site support

ACOUSTIC PERFORMANCE

Acoustic Standard ISO 15665 is an international standard that defines the acoustic performance of pipe insulation. This performance is categorised into classes A, B, C and D* based on measured acoustic insertion loss.

Furthermore, it defines a standardised test method for measuring the acoustic performance of any type of construction, thereby allowing existing and new insulation constructions to be rated against the specific classes.

Insulation systems are classified by their acoustic insertion loss performance and the diameter of pipe onto which they are applied. The standard allows noise control engineers to select the correct insulation system during the design stage in order to ensure that specified noise targets are met. ISO 15665 allows for any acoustic system configuration to be qualified providing that it meets the acoustic insertion loss requirements.

ISO 15665 classification table and Shell DEP Class D

Class	Nominal pipe diameter D (mm)		Octave band centre frequency Hz						
	Lower limit	Upper limit	125	250	500	1000	2000	4000	8000
	Minimum insertion loss (dB)								
A	A1	< 300	-4	-4	2	9	16	22	29
	A2	≥ 300 < 650	-4	-4	2	9	16	22	29
	A3	≥ 650 < 1,000	-4	2	7	13	19	24	30
B	B1	< 300	-9	-3	3	11	19	27	35
	B2	≥ 300 < 650	-9	-3	6	15	24	33	42
	B3	≥ 650 < 1,000	-7	2	11	20	29	36	42
C	C1	< 300	-5	-1	11	23	34	38	42
	C2	≥ 300 < 650	-7	4	14	24	34	38	42
	C3	≥ 650 < 1,000	1	9	17	26	34	38	42
D*	D2	≥ 300 < 650	-3	4	15	36	45	45	45
	D3	≥ 650 < 1,000	3	9	26	36	45	40	40

*Class D is classified according to Class D acc. to the Shell DEP 31.46.00.31 specification.

ArmaSound calculated broadband insertion loss

For typical industrial plants, measured calculated broadband insertion loss (noise reduction) of ArmaSound Industrial Systems is often higher than the minimum required in ISO 15665. See comparison in the table below:

ISO 15665 Specification / Performance dB(A)

	Control Valve	Centrifugal Compressor	Centrifugal Pump	Reciprocating Compressor
ISO 15665 - Class A2	14	10	4	5
ArmaSound Industrial System AF (EL)	16	12	5	7
ArmaSound Industrial System AF (MC)	20	17	11	13
ArmaSound Industrial System AF (GRP)	16	12	5	7
ArmaSound Industrial System AG (MC)	25	21	13	14
ArmaSound Industrial System AG (GRP)	26	22	14	15
ISO 15665 - Class B2	18	14	6	6
ArmaSound Industrial System AF (EL)	22	17	10	11
ArmaSound Industrial System AF (MC)	27	24	17	18
ArmaSound Industrial System AF (GRP)	22	18	11	11
ArmaSound Industrial System AG (MC)	25	21	13	14
ArmaSound Industrial System AG (GRP)	26	22	14	15
ISO 15665 - Class C2	24	20	11	10
ArmaSound Industrial System AF (EL)	29	24	16	16
ArmaSound Industrial System AF (MC)	32	27	18	19
ArmaSound Industrial System AF (GRP)	29	25	16	16
ArmaSound Industrial System AG (MC)	27	22	13	14
ArmaSound Industrial System AG (GRP)	26	22	13	14
SHELL DEP - Class D2	27	22	13	13
ArmaSound Industrial System AF (EL)	27	22	13	13
ArmaSound Industrial System AF (MC)	34	30	20	21
ArmaSound Industrial System AF (GRP)	31	26	16	15
ArmaSound Industrial System AG (MC)	28	24	14	15
ArmaSound Industrial System AG (GRP)	31	26	16	17

Based on ISO 15665 calculations.

Legend:

AF	ArmaFlex	EL	Elastomeric
MW	Mineral Wool	MC	Metal cladding
AG	ArmaGel	GRP	Glass reinforced plastic

ISO 15665 and SHELL DEP values for Classes A2, B2, C2 and D2 are based on mineral wool and metal jacketing.

THE COMPONENTS

ArmaSound Industrial Systems AF (EL) is based on ArmaFlex with elastomeric Arma-Chek R cladding.

- Results of testing:**
- Systems A, B and C according to ISO 15665
 - System D according to Shell DEP 31.46.00.31-Gen. specification

Conditions:
 Test results for nominal pipe-Ø: from 300mm to 650mm.
 Weight and thickness based on typical values. Industrial grade ArmaFlex materials are to be used for the ArmaFlex layers. All data and technical information are based on results achieved under typical application conditions.
 For each component the thickness in [mm] is provided.

ARMASOUND INDUSTRIAL SYSTEMS AF (EL)

CLASS A | AF (EL)

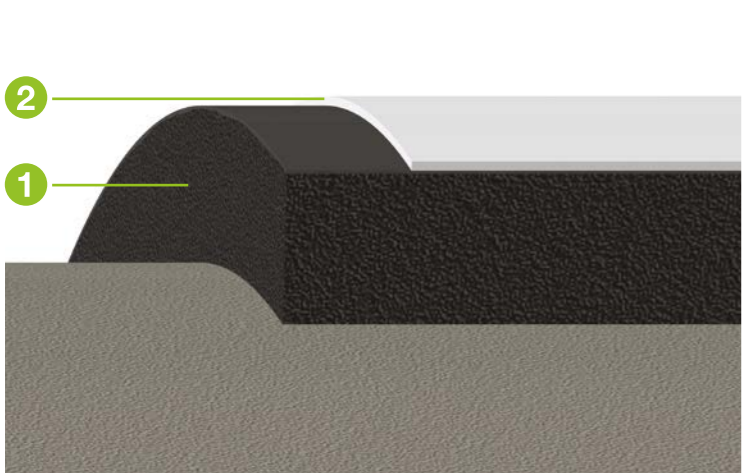

- 1 ArmaFlex Industrial 25 mm
- 2 Arma-Chek R 2 mm

CLASS B | AF (EL)

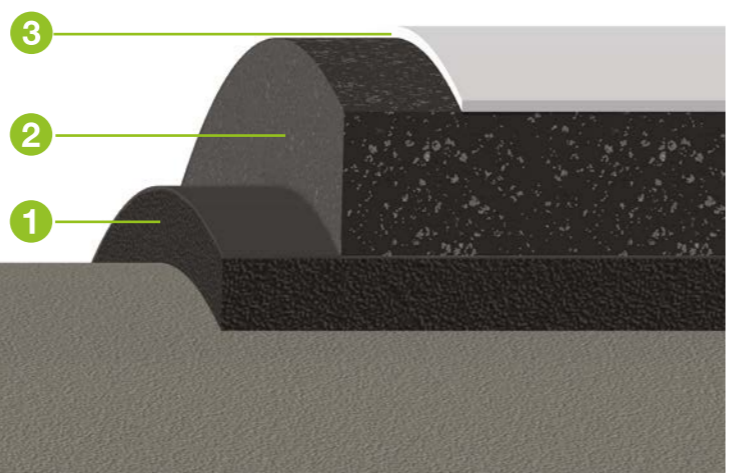

- 1 ArmaFlex Industrial 13 mm
- 2 ArmaSound RD240 25 mm
- 3 Arma-Chek R 2 mm

CLASS C | AF (EL)

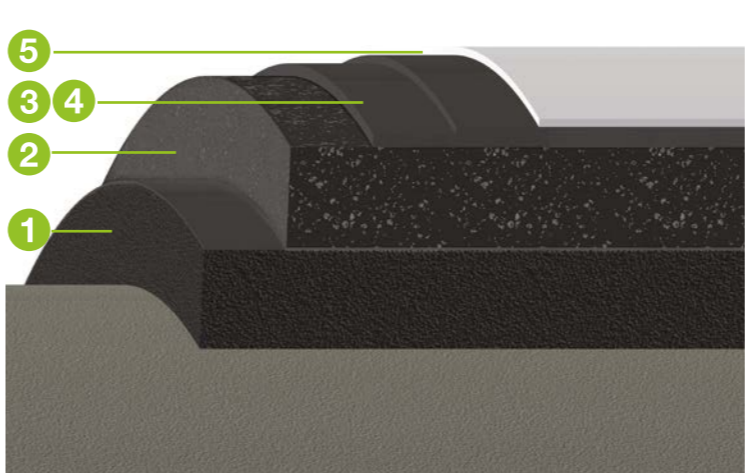

- 1 ArmaFlex Industrial 25 mm
- 2 ArmaSound RD240 25 mm
- 3 ArmaSound Barrier E 3 mm
- 4 ArmaSound Barrier E 2 mm
- 5 Arma-Chek R 2 mm

CLASS D | AF (EL)

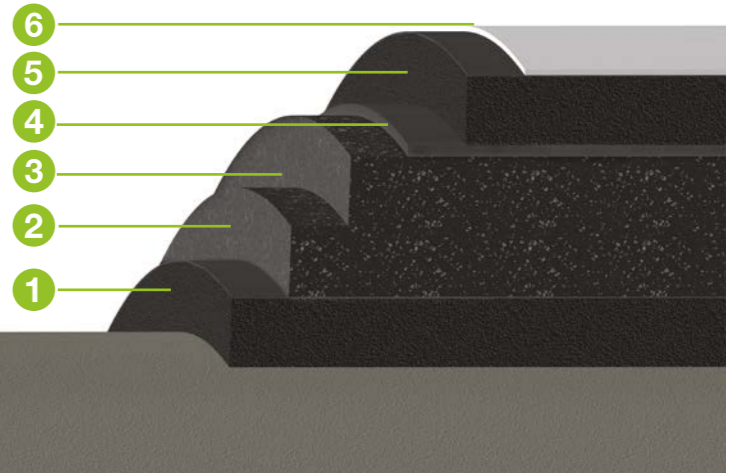

- 1 ArmaFlex Industrial 25 mm
- 2 ArmaSound RD240 25 mm
- 3 ArmaSound RD240 25 mm
- 4 ArmaSound Barrier E 4 mm
- 5 ArmaFlex Industrial 25 mm
- 6 Arma-Chek R 2 mm

Test results acc. to ISO 15665

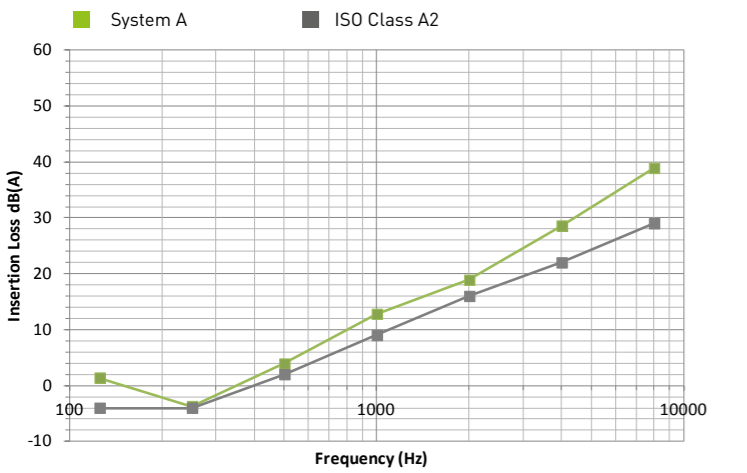

Test results	Octave band centre frequency Hz						
	125	250	500	1000	2000	4000	8000
Class A2							
Insertion loss, dB	1.4	-3.7	3.9	12.8	18.9	28.6	38.9
ISO 15665 Class A2	-4.0	-4.0	2.0	9.0	16.0	22.0	29.0

Total thickness (mm): 27.0
 Total weight, flat (kg/m²): 5.0

Test results acc. to ISO 15665

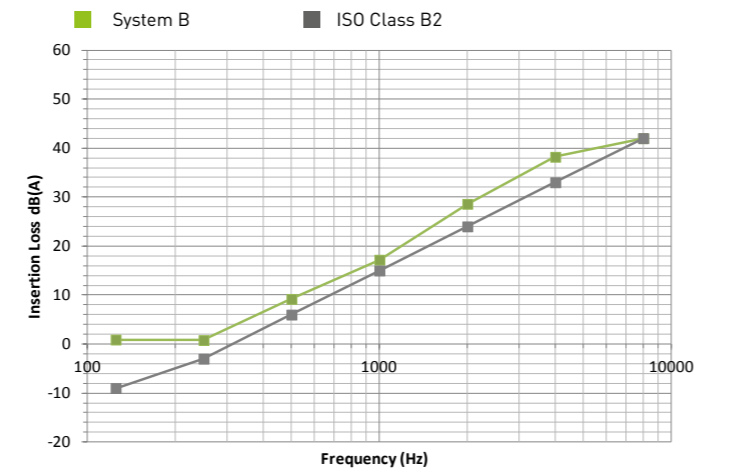

Test results	Octave band centre frequency Hz						
	125	250	500	1000	2000	4000	8000
Class B2							
Insertion loss, dB	0.9	0.8	9.2	17.2	28.6	38.2	42.0
ISO 15665 Class B2	-9.0	-3.0	6.0	15.0	24.0	33.0	42.0

Total thickness (mm): 40.0
 Total weight, flat (kg/m²): 10.1

Test results acc. to ISO 15665

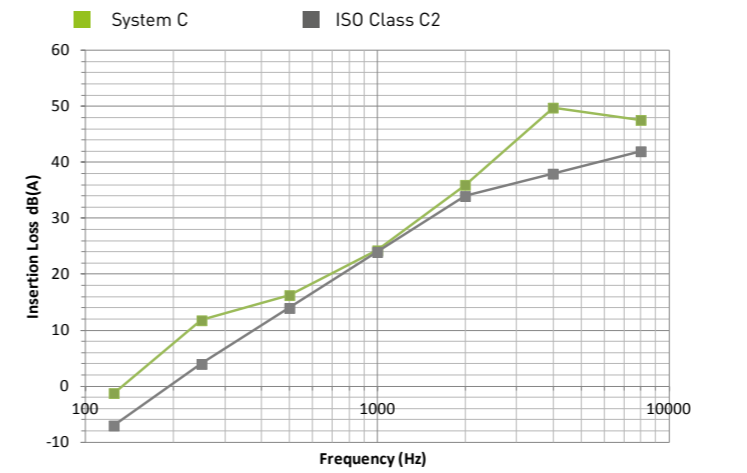

Test results	Octave band centre frequency Hz						
	125	250	500	1000	2000	4000	8000
Class C2							
Insertion loss, dB	-1.2	11.8	16.3	24.3	36.0	49.8	47.6
ISO 15665 Class C2	-7.0	4.0	14.0	24.0	34.0	38.0	42.0

Total thickness (mm): 57.0
 Total weight, flat (kg/m²): 23.5

Test results acc. to Shell DEP 31.46.00.31-Gen.

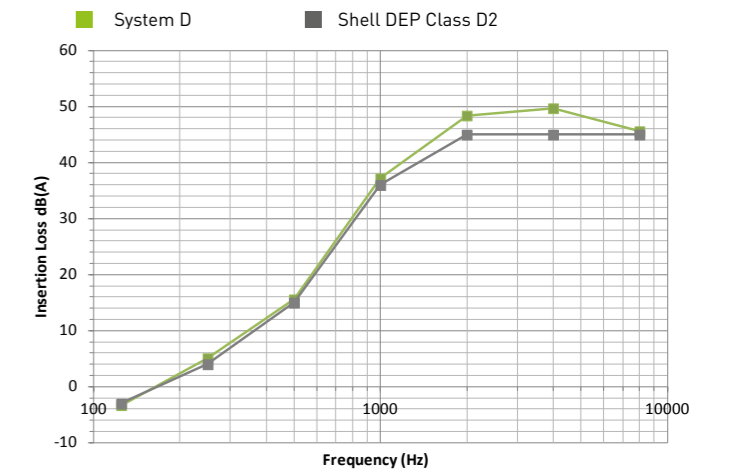

Test results	Octave band centre frequency Hz						
	125	250	500	1000	2000	4000	8000
Class D2							
Insertion loss, dB	-3.3	5.1	15.6	37.2	48.4	49.7	45.6
ISO 15665 Class D2	-3.0	4.0	15.0	36.0	45.0	45.0	45.0

Total thickness (mm): 106.0
 Total weight, flat (kg/m²): 28.7

THE COMPONENTS

ArmaSound Industrial Systems AF (MC) is based on ArmaFlex with metal cladding.

- Results of testing:**
- Systems A, B and C according to ISO 15665
 - System D according to Shell DEP 31.46.00.31-Gen. specification

Conditions:
 Test results for nominal pipe-Ø: from 300mm to 650mm.
 Weight and thickness based on typical values. Industrial grade ArmaFlex materials are to be used for the ArmaFlex layers. All data and technical information are based on results achieved under typical application conditions.
 For each component the thickness in [mm] is provided.

ARMASOUND INDUSTRIAL SYSTEMS AF (MC)

CLASS A | AF (MC)

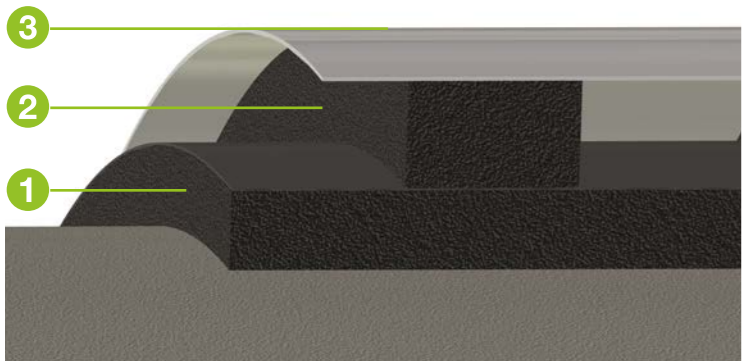

- 1 ArmaFlex Industrial 19 mm
- 2 ArmaFlex Spacer 25 mm
- 3 Steel Jacket 1 mm

CLASS B | AF (MC)

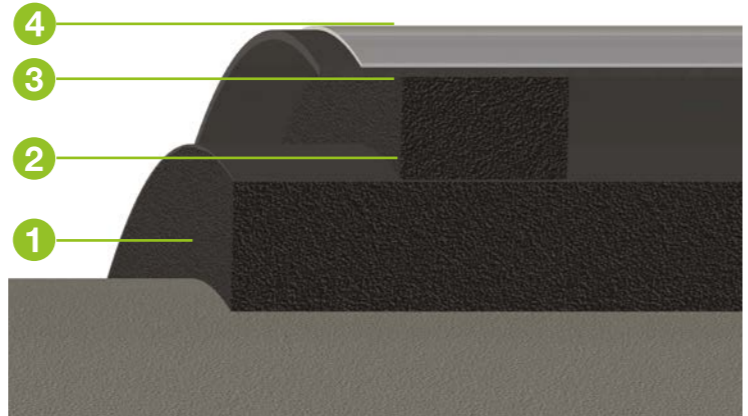

- 1 ArmaFlex Industrial 32 mm
- 2 ArmaFlex Spacer 25 mm
- 3 Bituminised Barrier 2.3 mm
- 4 Steel Jacket 1 mm

CLASS C | AF (MC)

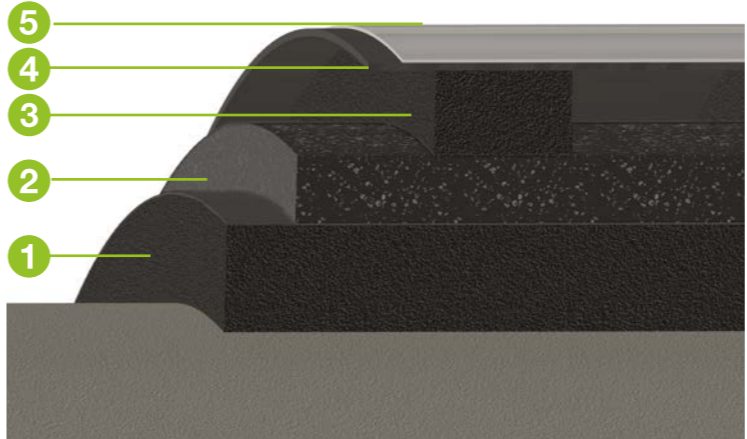

- 1 ArmaFlex Industrial 32 mm
- 2 ArmaSound RD240 20 mm
- 3 ArmaFlex Spacer 25 mm
- 4 Bituminised Barrier 2.3 mm
- 5 Steel Jacket 1 mm

CLASS D | AF (MC)

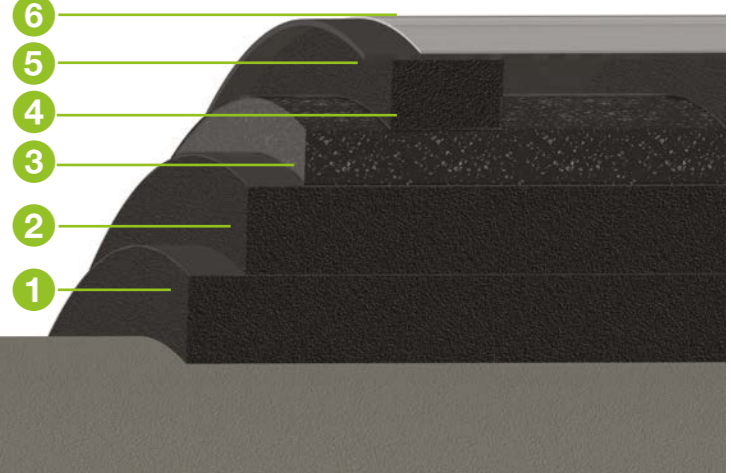

- 1 ArmaFlex Industrial 32 mm
- 2 ArmaSound RD240 20 mm
- 3 ArmaFlex Industrial 32 mm
- 4 ArmaFlex Spacer 25 mm
- 5 Bituminised Barrier 2.3 mm
- 6 Steel Jacket 1 mm

Test results acc. to ISO 15665

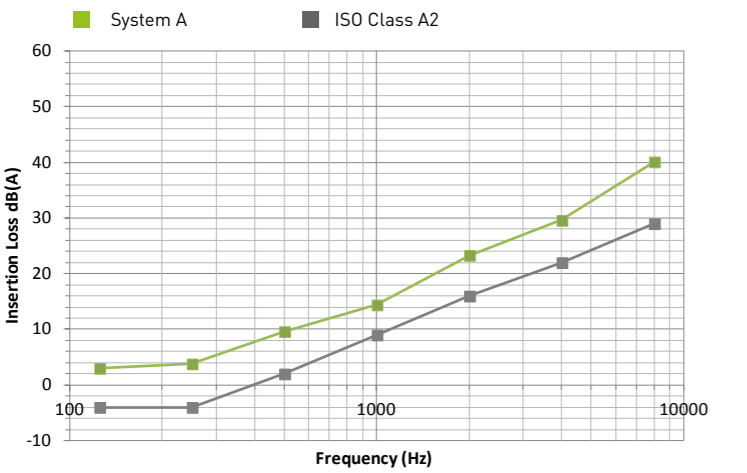

Test results	Octave band centre frequency Hz						
	125	250	500	1000	2000	4000	8000
Class A2							
Insertion loss, dB	3.0	3.8	9.6	14.4	23.3	29.6	40.1
ISO 15665 Class A2	-4.0	-4.0	2.0	9.0	16.0	22.0	29.0

Total thickness (mm): 45.0
 Total weight, flat (kg/m²): 9.4

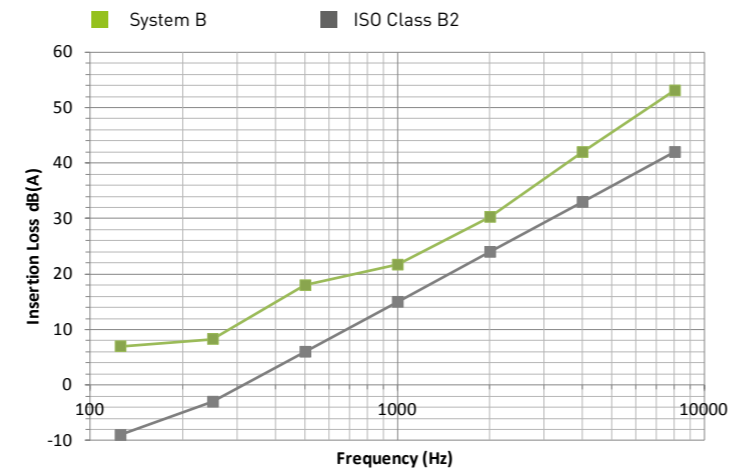

Test results	Octave band centre frequency Hz						
	125	250	500	1000	2000	4000	8000
Class B2							
Insertion loss, dB	7.0	8.3	18.0	21.7	30.3	42.0	53.1
ISO 15665 Class B2	-9.0	-3.0	6.0	15.0	24.0	33.0	42.0

Total thickness (mm): 60.3
 Total weight, flat (kg/m²): 13.1

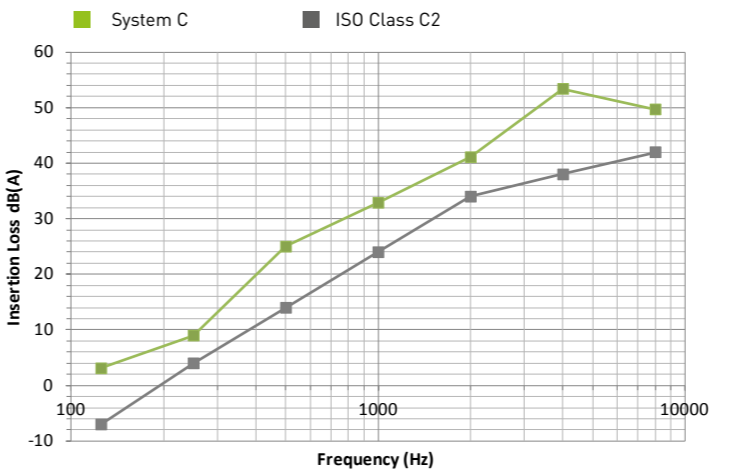

Test results	Octave band centre frequency Hz						
	125	250	500	1000	2000	4000	8000
Class C2							
Insertion loss, dB	3.1	9.0	25.0	32.9	41.1	53.4	49.7
ISO 15665 Class C2	-7.0	4.0	14.0	24.0	34.0	38.0	42.0

Total thickness (mm): 80.3
 Total weight, flat (kg/m²): 17.9

Test results acc. to Shell DEP 31.46.00.31-Gen.

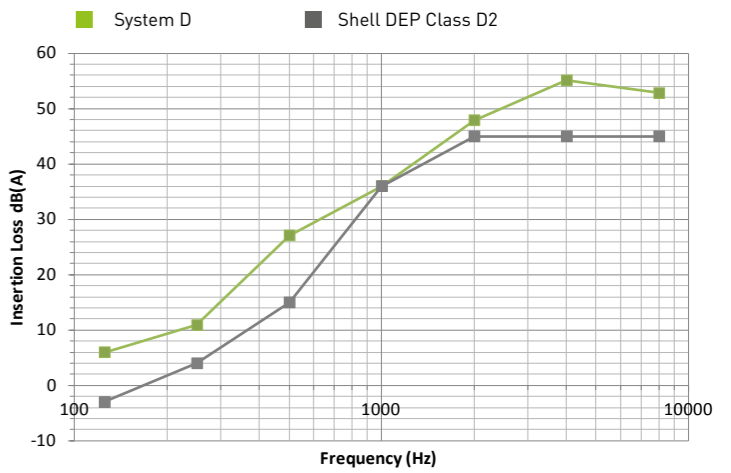

Test results	Octave band centre frequency Hz						
	125	250	500	1000	2000	4000	8000
Class D2							
Insertion loss, dB	6.0	10.9	27.1	36.0	47.9	55.1	52.8
ISO 15665 Class D2	-3.0	4.0	15.0	36.0	45.0	45.0	45.0

Total thickness (mm): 112.3
 Total weight, flat (kg/m²): 20.1

THE COMPONENTS

ArmaSound Industrial Systems AF (GRP) is based on ArmaFlex with GRP (glass-reinforced plastic) cladding.

- Results of testing:**
- Systems A, B and C according to ISO 15665
 - System D according to Shell DEP 31.46.00.31-Gen. specification

Conditions:
 Test results for nominal pipe-Ø: from 300mm to 650mm.
 Weight and thickness based on typical values. Industrial grade ArmaFlex materials are to be used for the ArmaFlex layers. All data and technical information are based on results achieved under typical application conditions.
 For each component the thickness in [mm] is provided.

ARMASOUND INDUSTRIAL SYSTEMS AF (GRP)

CLASS A | AF (GRP)

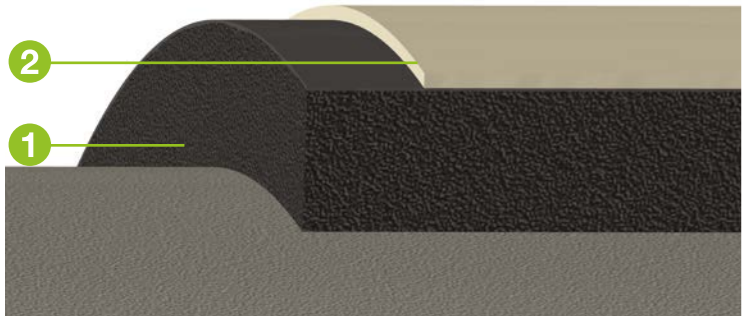

- 1 ArmaFlex Industrial 25 mm
- 2 GRP cladding 2.5 mm

CLASS B | AF (GRP)

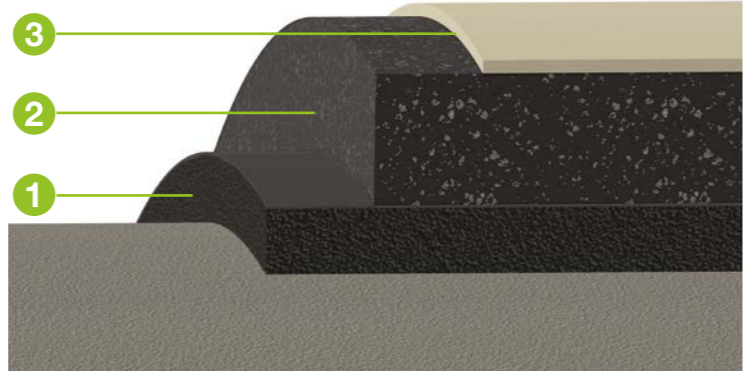

- 1 ArmaFlex Industrial 13 mm
- 2 ArmaSound RD240 25 mm
- 3 GRP cladding 2.5 mm

CLASS C | AF (GRP)

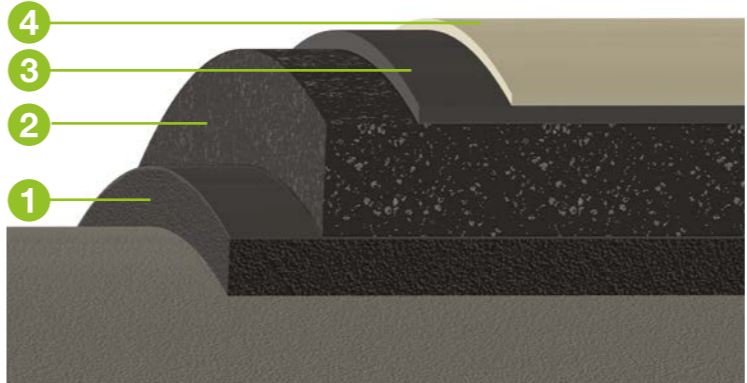

- 1 ArmaFlex Industrial 13 mm
- 2 ArmaSound RD240 25 mm
- 3 ArmaSound Barrier E 4 mm
- 4 GRP cladding 2.5 mm

CLASS D | AF (GRP)

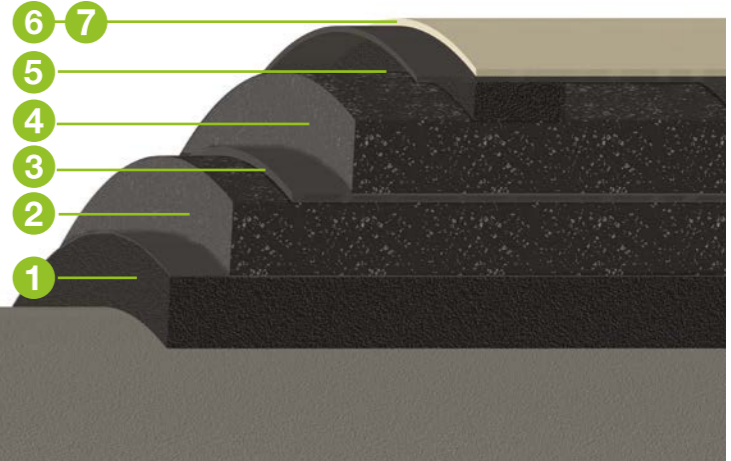

- 1 ArmaFlex Industrial 25 mm
- 2 ArmaSound RD240 25 mm
- 3 ArmaSound Barrier E 3 mm
- 4 ArmaSound RD240 25 mm
- 5 ArmaFlex Spacer 13 mm
- 6 ArmaSound Barrier E 2 mm
- 7 GRP cladding 2.5 mm

Test results acc. to ISO 15665

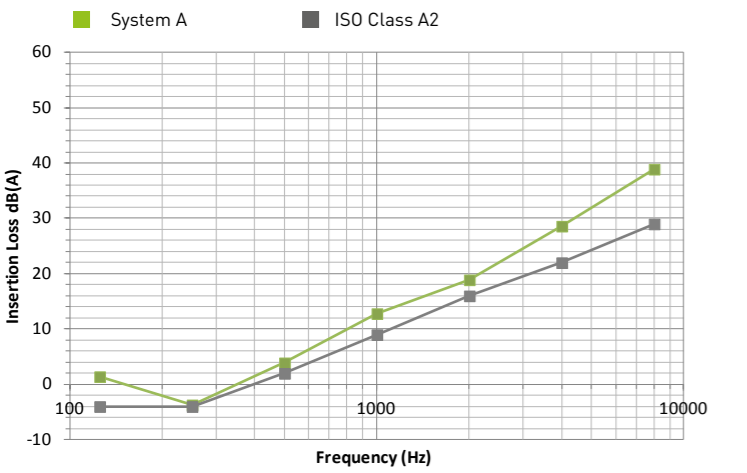

Test results	Octave band centre frequency Hz						
	125	250	500	1000	2000	4000	8000
Class A2							
Insertion loss, dB	1.4	-3.7	3.9	12.8	18.9	28.6	38.9
ISO 15665 Class A2	-4.0	-4.0	2.0	9.0	16.0	22.0	29.0

Total thickness (mm): 27.5
 Total weight, flat (kg/m²): 6.8

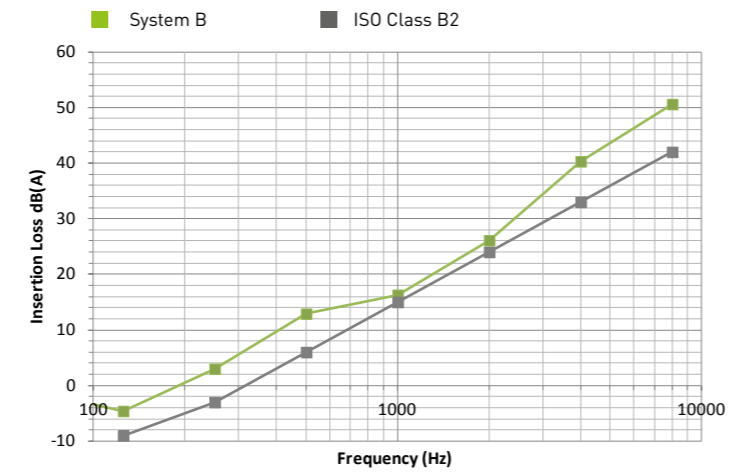

Test results	Octave band centre frequency Hz						
	125	250	500	1000	2000	4000	8000
Class B2							
Insertion loss, dB	-4.6	3.0	12.9	16.3	26.1	40.3	50.6
ISO 15665 Class B2	-9.0	-3.0	6.0	15.0	24.0	33.0	42.0

Total thickness (mm): 40.5
 Total weight, flat (kg/m²): 11.9

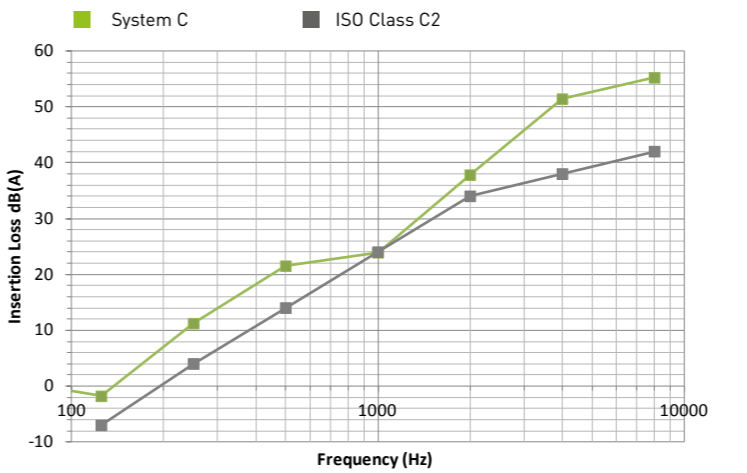

Test results	Octave band centre frequency Hz						
	125	250	500	1000	2000	4000	8000
Class C2							
Insertion loss, dB	-1.8	11.2	21.5	23.9	37.8	51.4	55.2
ISO 15665 Class C2	-7.0	4.0	14.0	24.0	34.0	38.0	42.0

Total thickness (mm): 44.5
 Total weight, flat (kg/m²): 21.9

Test results acc. to Shell DEP 31.46.00.31-Gen.

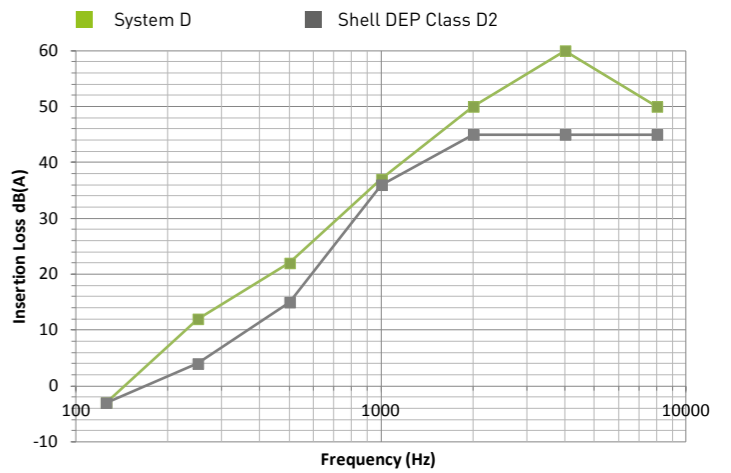

Test results	Octave band centre frequency Hz						
	125	250	500	1000	2000	4000	8000
Class D2							
Insertion loss, dB	-3.0	12.0	22.0	37.0	50.0	60.0	50.0
ISO 15665 Class D2	-3.0	4.0	15.0	36.0	45.0	45.0	45.0

Total thickness (mm): 95.5
 Total weight, flat (kg/m²): 31.6

THE COMPONENTS

ArmaSound Industrial Systems AG (MC) is based on ArmaGel with metal cladding.

- Results of testing:**
- Systems A, B and C according to ISO 15665
 - System D according to Shell DEP 31.46.00.31-Gen. specification

Conditions:
 Test results for nominal pipe-Ø: from 300mm to 650mm.
 Weight and thickness based on typical values. All data and technical information are based on results achieved under typical application conditions.
 For each component the thickness in [mm] is provided.

ARMASOUND INDUSTRIAL SYSTEMS AG (MC)

CLASS A | AG (MC)

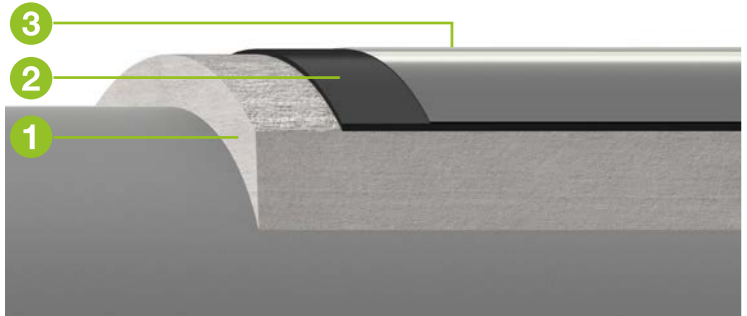

- 1 ArmaGel 20 mm
- 2 ArmaSound Barrier E 2 mm
- 3 Aluminium 0.5 mm

CLASS B | AG (MC)

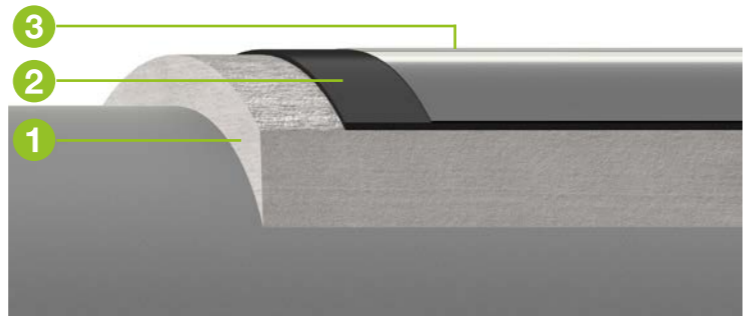

- 1 ArmaGel 20 mm
- 2 ArmaSound Barrier E 2 mm
- 3 Aluminium 0.5 mm

CLASS C | AG (MC)

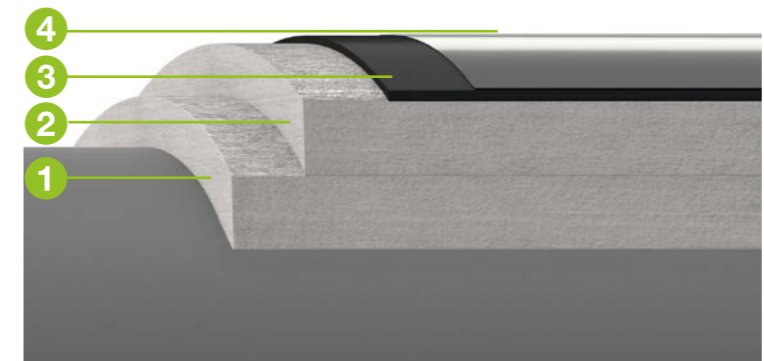

- 1 ArmaGel 20 mm
- 2 ArmaSound Barrier E 20 mm
- 3 ArmaSound Barrier E 3 mm
- 4 Aluminium 0.5 mm

CLASS D | AG (MC)

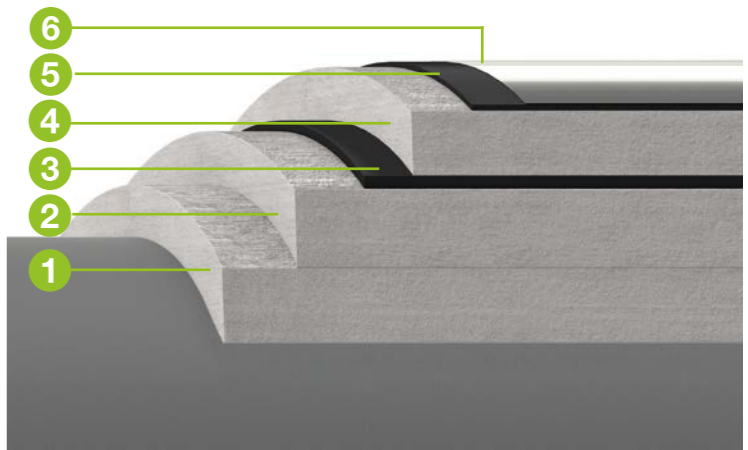

- 1 ArmaGel 20 mm
- 2 ArmaSound Barrier E 20 mm
- 3 ArmaSound Barrier E 4 mm
- 4 ArmaGel 20 mm
- 5 ArmaSound Barrier E 2 mm
- 6 Stainless Steel 0.4 mm

Test results acc. to ISO 15665

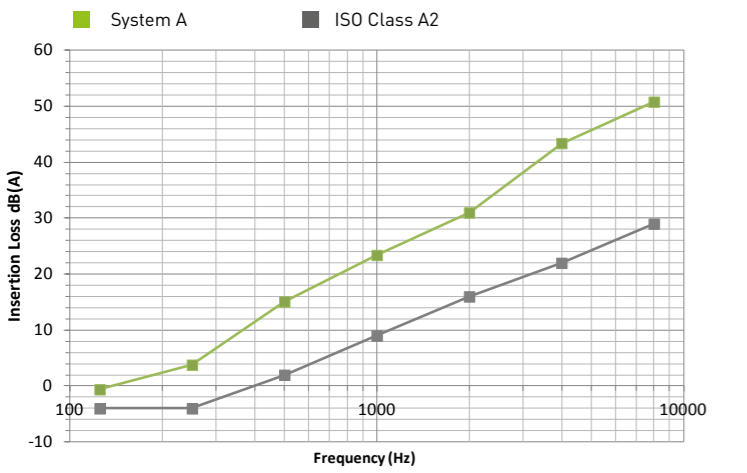

Test results	Octave band centre frequency Hz						
	125	250	500	1000	2000	4000	8000
Class A2							
Insertion loss, dB	-0.6	3.8	15.1	23.4	31.0	43.4	50.8
ISO 15665 Class A2	-4.0	-4.0	2.0	9.0	16.0	22.0	29.0

Total thickness (mm): 22.5
 Total weight, flat (kg/m²): 10.5

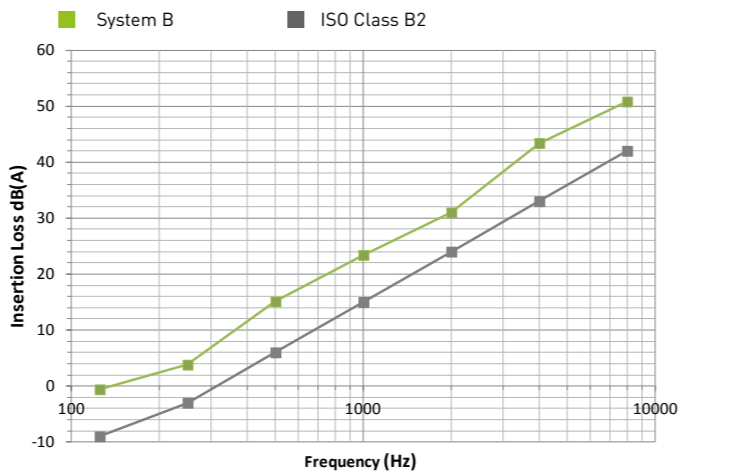

Test results	Octave band centre frequency Hz						
	125	250	500	1000	2000	4000	8000
Class B2							
Insertion loss, dB	-0.6	3.8	15.1	23.4	31.0	43.4	50.8
ISO 15665 Class B2	-9.0	-3.0	6.0	15.0	24.0	33.0	42.0

Total thickness (mm): 22.5
 Total weight, flat (kg/m²): 10.5

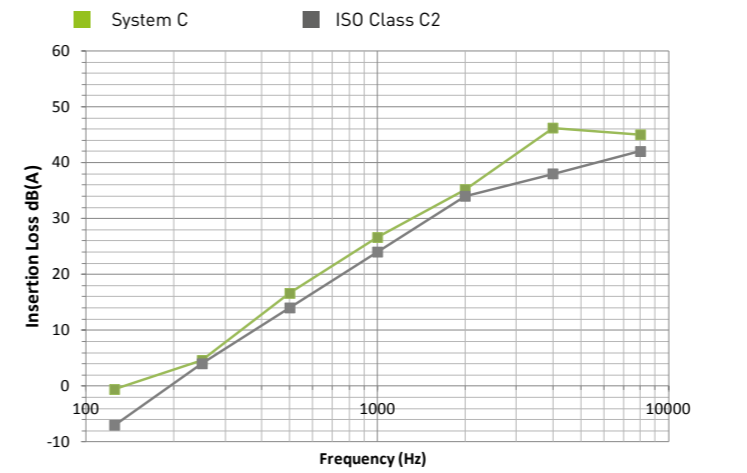

Test results	Octave band centre frequency Hz						
	125	250	500	1000	2000	4000	8000
Class C2							
Insertion loss, dB	-0.6	4.6	16.6	26.6	35.2	46.2	45.0
ISO 15665 Class C2	-7.0	4.0	14.0	24.0	34.0	38.0	42.0

Total thickness (mm): 43.5
 Total weight, flat (kg/m²): 17.1

Test results acc. to Shell DEP 31.46.00.31-Gen.

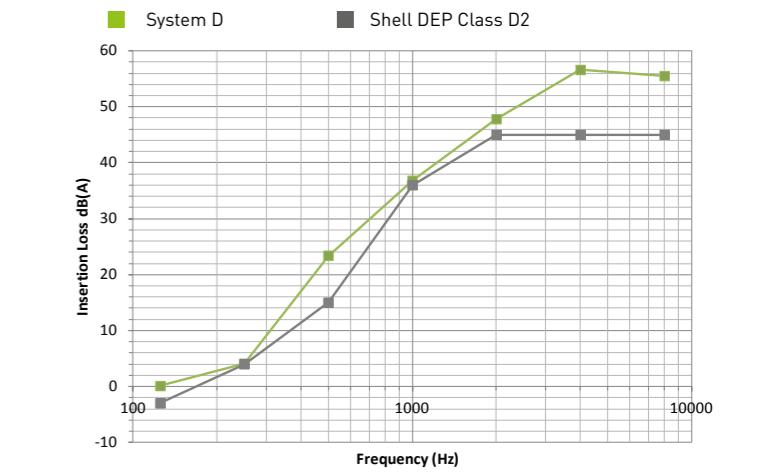

Test results	Octave band centre frequency Hz						
	125	250	500	1000	2000	4000	8000
Class D2							
Insertion loss, dB	0.1	4.1	23.4	36.8	47.8	56.6	55.5
ISO 15665 Class D2	-3.0	4.0	15.0	45.0	45.0	45.0	45.0

Total thickness (mm): 66.4
 Total weight, flat (kg/m²): 30.6

THE COMPONENTS

ArmaSound Industrial Systems AG (GRP) is based on ArmaGel with GRP (glass-reinforced plastic) cladding.

- Results of testing:**
- Systems A, B and C according to ISO 15665
 - System D according to Shell DEP 31.46.00.31-Gen. specification

Conditions:
 Test results for nominal pipe-Ø: from 300mm to 650mm.
 Weight and thickness based on typical values. All data and technical information are based on results achieved under typical application conditions.
 For each component the thickness in [mm] is provided.

ARMASOUND INDUSTRIAL SYSTEMS AG (GRP)

CLASS A | AG (GRP)

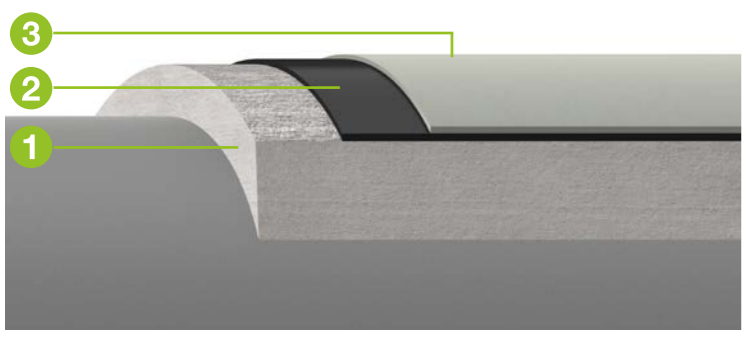

- 1 ArmaGel 20 mm
- 2 ArmaSound Barrier E 2 mm
- 3 GRP 1.8 mm

CLASS B | AG (GRP)

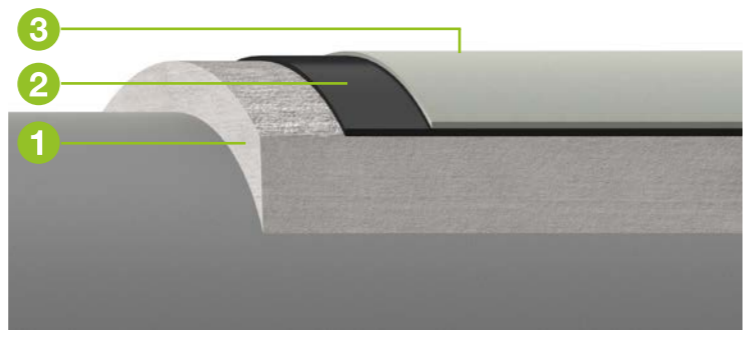

- 1 ArmaGel 20 mm
- 2 ArmaSound Barrier E 2 mm
- 3 GRP 1.8 mm

CLASS C | AG (GRP)

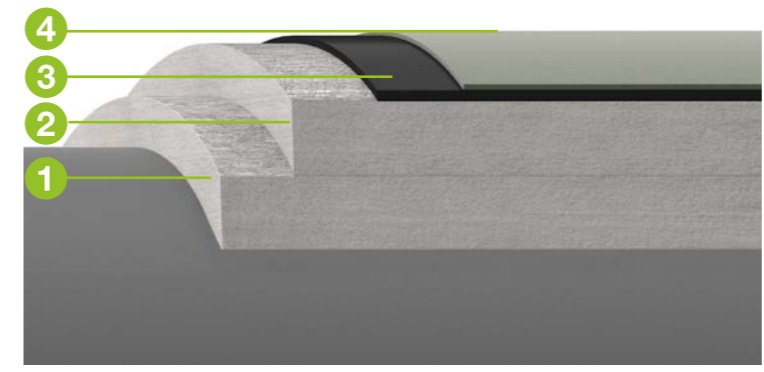

- 1 ArmaGel 20 mm
- 2 ArmaSound Barrier E 20 mm
- 3 ArmaSound Barrier E 3 mm
- 4 GRP 1.8 mm

CLASS D | AG (GRP)

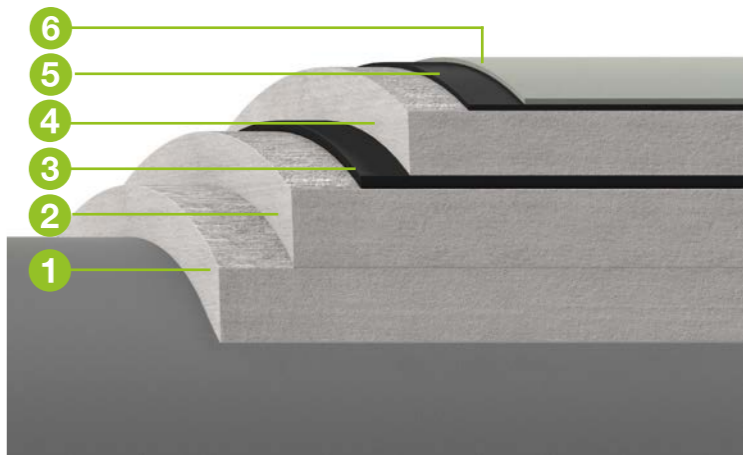

- 1 ArmaGel 20 mm
- 2 ArmaSound Barrier E 20 mm
- 3 ArmaSound Barrier E 4 mm
- 4 ArmaGel 20 mm
- 5 ArmaSound Barrier E 4 mm
- 6 GRP 1.8 mm

Test results acc. to ISO 15665

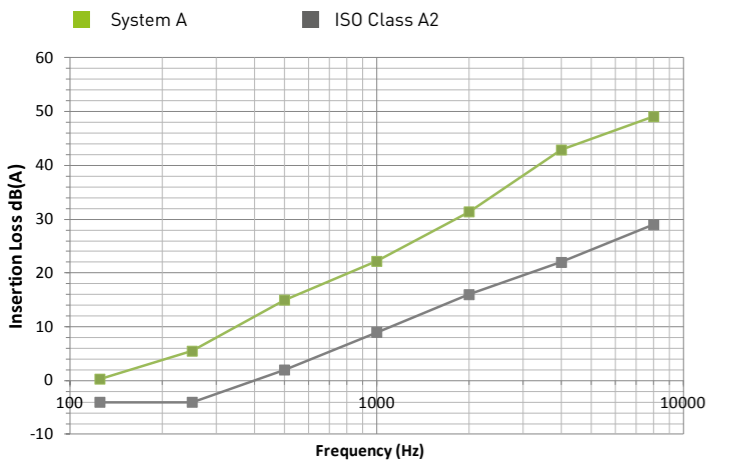

Test results	Octave band centre frequency Hz						
	125	250	500	1000	2000	4000	8000
Class A2							
Insertion loss, dB	0.3	5.5	15.0	22.2	31.4	42.9	49.1
ISO 15665 Class A2	-4.0	-4.0	2.0	9.0	16.0	22.0	29.0

Total thickness (mm): 23.8
 Total weight, flat (kg/m²): 12.7

Test results acc. to ISO 15665

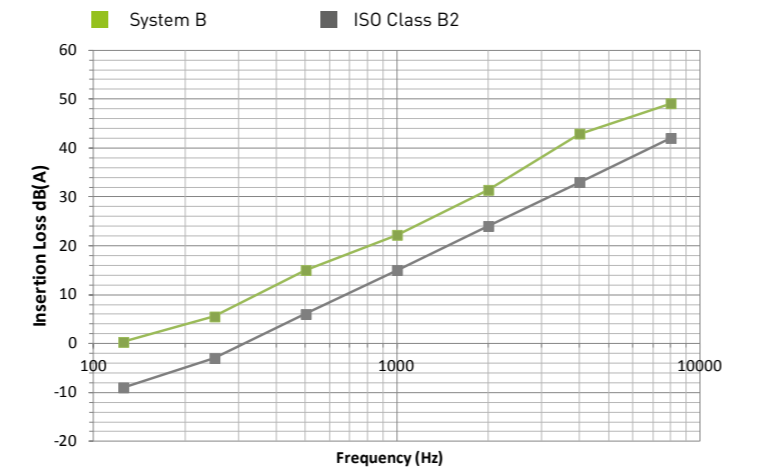

Test results	Octave band centre frequency Hz						
	125	250	500	1000	2000	4000	8000
Class B2							
Insertion loss, dB	0.3	5.5	15.0	22.2	31.4	42.9	49.1
ISO 15665 Class B2	-9.0	-3.0	6.0	15.0	24.0	33.0	42.0

Total thickness (mm): 23.8
 Total weight, flat (kg/m²): 12.7

Test results acc. to ISO 15665

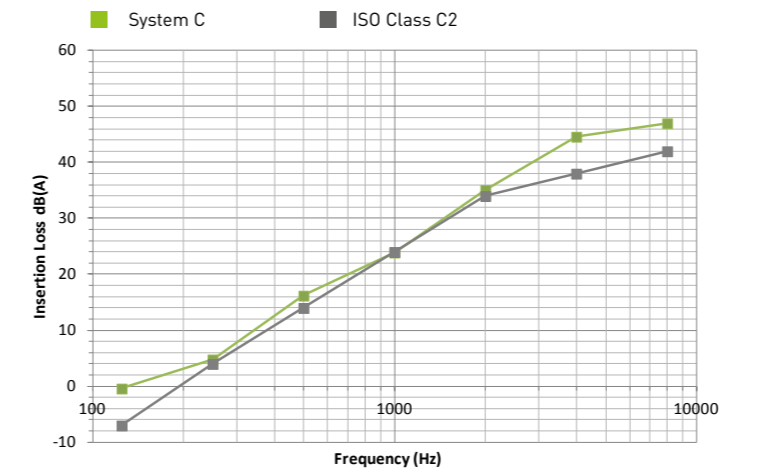

Test results	Octave band centre frequency Hz						
	125	250	500	1000	2000	4000	8000
Class C2							
Insertion loss, dB	-0.4	4.8	16.2	23.9	35.1	44.6	47.0
ISO 15665 Class C2	-7.0	4.0	14.0	24.0	34.0	38.0	42.0

Total thickness (mm): 44.8
 Total weight, flat (kg/m²): 19.2

Test results acc. to Shell DEP 31.46.00.31-Gen.

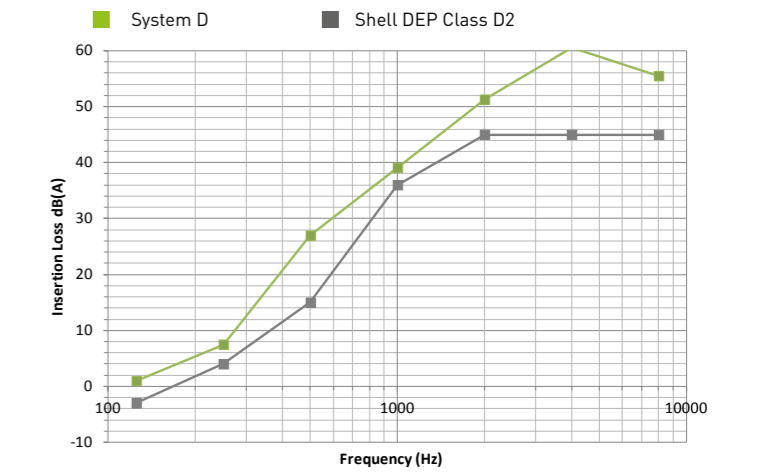

Test results	Octave band centre frequency Hz						
	125	250	500	1000	2000	4000	8000
Class D2							
Insertion loss, dB	1.0	7.5	27.0	39.1	51.3	60.5	55.5
ISO 15665 Class D2	-3.0	4.0	15.0	36.0	45.0	45.0	45.0

Total thickness (mm): 69.8
 Total weight, flat (kg/m²): 36.2

// Armacell Engineered Systems Ltd | Head Office
London • United Kingdom

// Phone
+44 330 880 4040 [Office hours: 9:00 - 17:00 UK]

// Email
General enquiries oilandgas@armacell.com
Technical enquiries technical.oilandgas@armacell.com

All data and technical information are based on results achieved under the specific conditions defined according to the testing standards referenced. It is the customer's responsibility to verify if the product is suitable for the intended application. The responsibility for professional and correct installation and compliance with relevant building regulations lies with the customer. Armacell takes every precaution to ensure the accuracy of the data provided in this document and all statements, technical information and recommendations contained within are believed to be correct at the time of publication. By ordering/receiving product you accept the **Armacell General Terms and Conditions of Sale** applicable in the region. Please request a copy if you have not received these.

© Armacell, 2018. ArmaGel is a trademark of the Armacell Group. ® and TM are trademarks of the Armacell Group and is registered in the European Union, United States of America, and other countries.
0084 | ArmaSound | ASIS ES | Brochure | 082018 | Global | EN Master

ABOUT ARMACELL

As the inventors of flexible foam for equipment insulation and a leading provider of engineered foams, Armacell develops innovative and safe thermal, acoustic and mechanical solutions that create sustainable value for its customers. Armacell's products significantly contribute to global energy efficiency making a difference around the world every day. With 3,000 employees and 27 production plants in 17 countries, the company operates two main businesses, Advanced Insulation and Engineered Foams. Armacell focuses on insulation materials for technical equipment, high-performance foams for high-tech and lightweight applications and next generation aerogel blanket technology.

For more information, please visit:
www.armacell.com/oilandgas

MAKING A DIFFERENCE AROUND THE WORLD